

Maya

restyle

STOSA
CUCINE

STOSA - UNA FAMIGLIA ITALIANA - 50 ANNI DI STORIA E UNA SOLA GRANDE PASSIONE LA CUCINA

Da 50 anni produciamo solo cucine, create e prodotte per migliorare la vita di chi, ogni giorno, vive nello spazio più conviviale della casa. Progettiamo e realizziamo esclusivamente in Italia prodotti eccellenti nella qualità, realmente sostenibili per ogni famiglia italiana e per i giovani. Ecco perché una cucina Stosa nasce da valori autentici come impegno, onestà, rispetto e originalità. In Italia e in oltre 40 Paesi nel mondo, con un mercato in costante espansione. Impegno per dare il meglio di noi attraverso ogni singola cucina, direttamente a casa tua. Onestà per trasformare i nostri progetti in spazi di vita davvero sostenibili. Rispetto per la natura che ci circonda e per tutta la filiera produttiva. Originalità per essere sempre più competitivi nell'innovazione tecnologica e funzionale. È così che ogni giorno costruiamo le nostre cucine. Pensando a te.

STOSA, AN ITALIAN FAMILY. 50 YEARS OF HISTORY AND ONE GREAT PASSION: KITCHENS.

For 50 years we've been producing only kitchens, designed and built for those who enjoy spending time in the most welcoming room in the home. Our products, designed and made entirely in Italy, stand out for their quality yet are affordable for Italian families and young people. Because a Stosa kitchen is based on authentic values like commitment, honesty, respect and originality in Italy and a further 40 countries worldwide, with a constantly growing market. Commitment to offer our best in every single kitchen, directly in your own home. Honesty to turn our designs into truly sustainable living areas. Respect for the nature surrounding us and for the whole production chain. Originality to be more and more competitive with regards technological and practical innovation. That's how we build our kitchens every day. Thinking of you.



Maya
restyle

kitchen solutions

*MAYA CAMBIA LOOK
e si rinnova con più colori, nuove
finiture e inediti abbinamenti che
creano molteplici stili. Maya è la
cucina dalla personalità poliedrica,
mai uguale a sé stessa e sempre pronta
a cambiare per adattarsi ai lifestyle
contemporanei. Legni, tonalità decise
e tinte neutre, geometrie e forme
morbide: tante Maya per tutti i gusti.*

*MAYA GOES FOR A NEW LOOK
with more colours, new finishes and
never before seen pairings to create
a variety of styles. Maya is a kitchen
with a multifaceted personality, never
repetitive and always ready to adapt to
contemporary lifestyles.
Wood, bold tones and neutral colours,
geometrical and soft shapes: Maya
kitchens suit any taste.*





Maya restyle kitchen solutions

WOOD style



Più stili in un unico modello e infinite possibilità di personalizzare il cuore della casa. Il legno mette la cucina in contatto con la natura, i colori accendono la contemporaneità, i tagli grafici esaltano il design, i contrasti materici danno un aspetto metropolitano, le curve esprimono una tendenza soft. Ad ogni stile, la sua Maya.

A single model offering multiple styles and the opportunity to personalise the heart of the home. Wood keeps the kitchen in touch with nature, colours highlight modernity and graphic cuts bring out the design, textured contrasts make for a metropolitan feel, while curves express a softer side. There's a Maya for every style.

COMP. 01 | page 4

DESIGN style



COMP. 08 | page 50



COMP. 09 | page 54



COMP. 10 | page 58

COLORS style



COMP. 02 | page 14



COMP. 03 | page 20



COMP. 04 | page 26

URBAN style



COMP. 11 | page 66



COMP. 12 | page 74



COMP. 13 | page 78

NATURAL style



COMP. 05 | page 32



COMP. 06 | page 38



COMP. 07 | page 46

ROUND style



COMP. 14 | page 82



COMP. 15 | page 86

WOOD *style*

kitchen solution

SUPERMATT / BIANCO PURO OPACO



SURPERMATT LUX / CARTA ZUCCHERO OPACO

IDEA *for*
DECOR

WALL PAPER
INSPIRATION



MAYA COMPOSIZIONE 01 . L'essenza Wood è protagonista assoluta e riproduce la naturalezza del legno appena tagliato, con le sue perfette imperfezioni. Insieme a finiture lisce, lucide e opache, e alla carta da parati in stile raw, la cucina è un'armonia di materiali e colori. Per un ambiente che unisce allo spirito contemporaneo un'autentica anima artigianale.

MAYA COMPOSITION 01. The Wood essence is the undisputed star as it recreates the natural feel of freshly cut wood, with its perfect imperfections. Smooth, glossy and matt finishes and raw-style wallpaper bring harmony to the materials and colours in the kitchen. For an environment that resonates with a craftsman's soul and a contemporary vibe.



Maya 5



COMPOSITION | 01

Basi e pensili alti in Supermatt Bianco Puro. Colonne midi in Supermatt Lux Carta Zucchero opaco. Pensili, base tavolo e dispense Wood. Top, alzatina e fianchi in quarzo Pietra del Carso Velvet. Gola e zoccolo in finitura Titanio. Cappa Itaca.

Base units and wall units in Bianco Puro Supermatt. Midi tall units in Lux Carta Zucchero Opaco Supermatt. Wood wall units, table base and larders. Top, upstand and side in Pietra del Carso Velvet quartz. Titanio groove and plinth. Itaca Hood.

Maya 7



Le vetrinette dispensa appartengono alle cucine del passato ma sono ancora oggi soluzioni originali.

The larder's glass doors are an echo from the kitchens of the past, but remain a creative solution even today.



Maya
WOOD*style*
la cucina creativa

A creative kitchen



25/08/16
CF16054A001 PD



Banco multifunzionale

In linea con gli arredi della cucina come zona cottura oppure stand-alone in centro stanza come tavolo o piano di lavoro, il banco è un elemento nuovo e molto pratico.

Multi-purpose counter: In line with the kitchen furniture either for the cooking area or as a stand-alone, placed in the centre of the room as a table or work area, this counter is a very practical never before seen element.



COLORS *style*

kitchen solution

IDEA *for*
DECOR

DESIGN
INSPIRATION

SURPERMATT LUX / VERDE ACQUA OPACO

SURPERMATT / DESERT OPACO

NOCE PLATIN

MAYA COMPOSIZIONE 02. La delicatezza del verde pastello, la leggerezza del Noce Platin e il pattern delle cementine evocano un'atmosfera anni '50 più attuale che mai. Un mood vintage caratterizzato da linee semplici, maniglie sinuose e arredi dal sapore retrò. Per chi ama portare in cucina tutto il fascino di un'epoca intramontabile.

MAYA COMPOSITION 02. Delicate pastel green and lightweight Noce Platin blend with the pattern on the tiles for a '50s feel with a modern touch. Simple lines, sinuous handles and deliciously retro furniture accompany the vintage mood. A kitchen for those fascinated by a timeless era.



COMPOSITION | 02 *Base in Supermatt Lur Verde Acqua opaco. Pensili in Supermatt Desert opaco. Colonne, cappa e pensile in Noce Platin. Maniglia Onda e zoccolo in finitura Peltro. Top e alzatina in marmo Grabla Levigato.*

Lur Verde Acqua Opaco Supermatt base unit. Desert Opaco Supermatt wall unit. Noce Platin tall unit, hood and wall unit. Onda handle and Peltro plinth and finish. Grabla Levigato marble top and upstand.





Ispirazione Fifties per la madia quadrata con struttura e piedini in finitura Peltro e frontali abbinati alla cucina.

Peltro finish for the frame and feet of the Fifties-style square cupboard with doors matching the kitchen.



03 | **COLORS** *style*
ESEMPI DI ABBINAMENTI / PAIRING EXAMPLES

IDEA *for*
DECOR

WALL PAPER
INSPIRATION

SURPERMATT LUX / ROSSO MATTONE OPACO



SURPERMATT LUX / CIPRIA OPACO



NOCE PLATIN

MAYA COMPOSIZIONE 03. Un tocco di rosso ravviva le tonalità chiare, effetto legno o laccate, mentre le maioliche old-style in versione wallpaper decorano la parete dietro i fornelli. Una cucina dallo spirito mediterraneo reinterpretato con colori attuali, pensata per chi vuole creare un'atmosfera accogliente che profuma di famiglia.

MAYA COMPOSITION 03. A touch of red livens up the light colours, wood or lacquered effect, while old-style wallpaper maiolicas decorate the wall behind the stove. A kitchen with a Mediterranean feel and modern colours, for a welcoming family atmosphere.



COMPOSITION | 03 *Colonne e basi in Noce Platin e Supermatt Rosso Mattone opaco. Pensili Supermatt Cipria opaco con vano a giorno laccato Bianco opaco. Top in Luserna Bianco, zoccolo e gola in finitura Titanio.*

Noce Platin tall unit and base unit and Rosso Mattone Opaco Supermatt. Cipria Opaco Supermatt wall units with Bianco Opaco lacquered open cupboard. Luserna Bianco top, plinth and groove with a Titanio finish.





Maya è multifunzionale: il tavolo a muro diventa scrivania creando un pratico angolo home office in cucina.

Maya is multifunctional: the wall table becomes a desk, creating a practical home office corner in the kitchen.



04 | **COLORS** *style*
ESEMPI DI ABBINAMENTI / PAIRING EXAMPLES

IDEA *for*
DECOR

WALL PAPER
INSPIRATION

SURPERMATT LUX / NEBBIA OPACO

SURPERMATT LUX / CARTA ZUCCHERO OPACO

SURPERMATT LUX / GRIGIO FERRO OPACO

MAYA COMPOSIZIONE 04. Una palette variegata per un perfetto equilibrio di sapori: un pizzico di azzurro, un tocco di grigio quanto basta aggiungono colore alle texture del legno e il mix grafico della carta da parati alza il tono decorativo della cucina. Per chi predilige gli abbinamenti originali senza rinunciare alla semplicità.

MAYA COMPOSIZIONE 04. A varied palette for perfectly balanced tastes: a pinch of sky blue and just a touch of grey add colour to the wood textures and the graphic mix on the wallpaper elevates the decorative mood in the kitchen. For those who love both simplicity and creative pairings.





COMPOSITION | 04

Basi in Supermatt Lux Carta Zucchero opaco con maniglia Bronzo titanio MVAB. Pensili in Supermatt Lux nei colori Grigio Ferro opaco e Carta Zucchero opaco, cappa in Supermatt Lux Grigio Ferro opaco. Colonne in Supermatt Lux Carta Zucchero opaco. Elementi Tetris in laminato Olmo Mercurio, elementi Jolly Evo in finitura Olmo Mercurio e Desert opaco. Top e alzata in Fenix Grigio Londra. Zoccolo in finitura Peltro.

Lux Carta Zucchero Opaco Supermatt base units with Bronzo titanio MVAB handles. Lux Supermatt wall units in Grigio Ferro Opaco and Carta Zucchero Opaco, Lux Grigio Ferro Supermatt hood. Lux Carta Zucchero Opaco Supermatt tall units. Olmo Mercurio laminate Tetris Elements, Jolly Evo Elements with Olmo Mercurio and Desert Opaco finishes. Fenix Grigio Londra top and stand. Peltro finish plinth.



Il tavolo-snack con top effetto legno e gambe in ferro introduce in cucina un nuovo stile per la convivialità.

The snack table with a wood-effect top and steel legs introduces a new style to those shared moments in the kitchen.



Una cucina multifunzione, sempre più aperta sull'ambiente giorno del quale è ormai parte integrante: l'estetica e la modularità si modificano per venire incontro a queste nuove esigenze dell'abitare contemporaneo.

A multitasking kitchen, increasingly open to the day area as the two have developed into a single unit: aesthetics and a modular approach allow for changes that better suit the needs of the modern home.

NATURAL *style*

kitchen solution

SURPERMATT LUX / CARTA ZUCCHERO OPACO

SURPERMATT / BIANCO PURO OPACO

IDEA *for*
DECOR

WALL PAPER
INSPIRATION

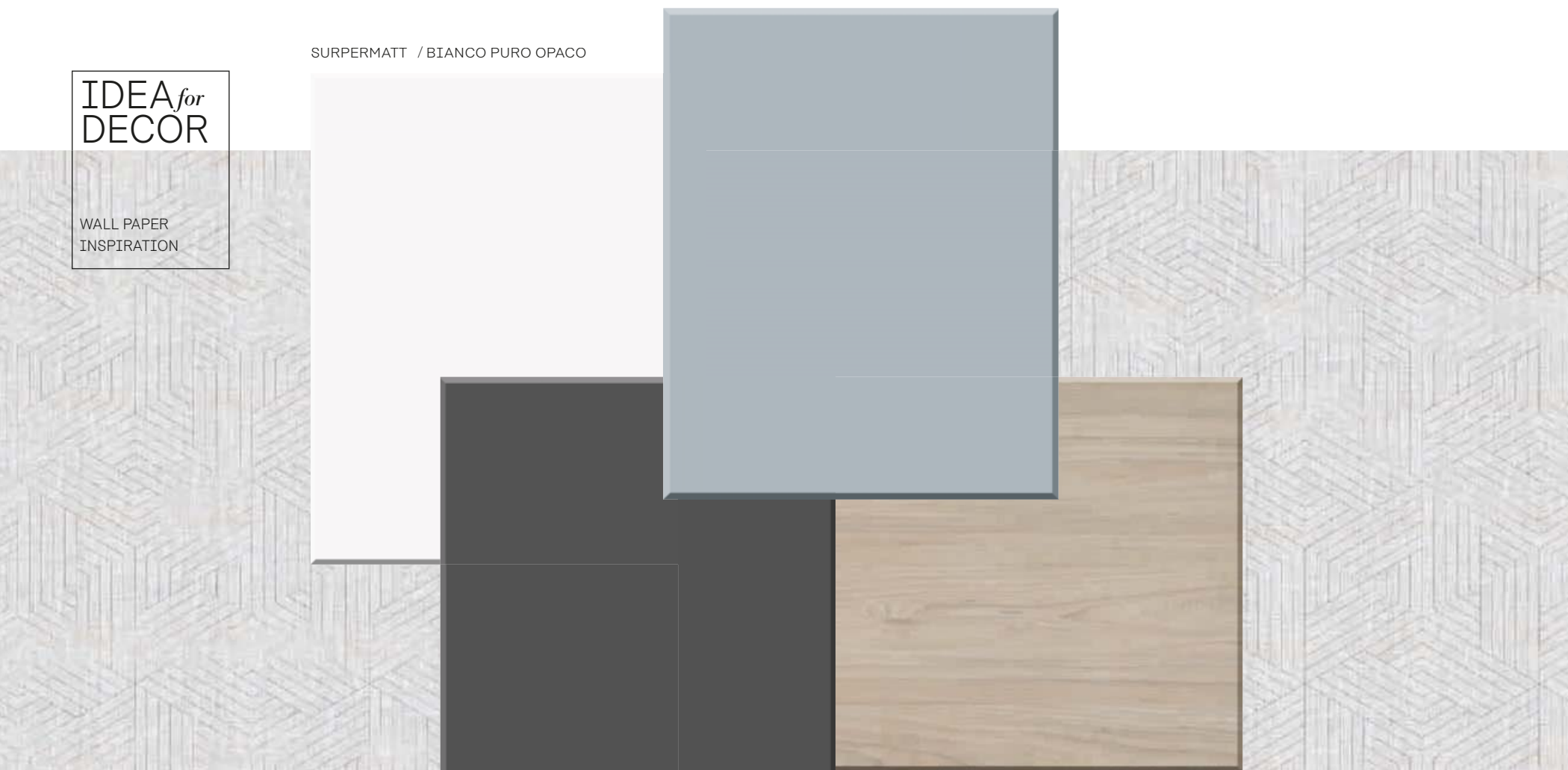

OLMO BIANCO PER SCHIENALE

SURPERMATT LUX / GRIGIO FERRO OPACO

MAYA COMPOSIZIONE 05. Il grey & white si ammorbidisce accostato a un legno chiaro e prende un po' colore con la carta da zucchero. La naturalezza si esprime attraverso una combinazione di ingredienti ben bilanciata, perfetta per chi vuole portare in cucina la modernità del grigio e bianco senza rinunciare al calore delle venature.

MAYA COMPOSITION 05. Grey & white are softened by being paired with light wood while Carta da Zucchero adds a little colour. A well balanced combination of ingredients help everything feel natural, perfect for those who want the modern effect of grey and white colours without renouncing the warmth of wood grain.



Basi e pensili Supermatt Bianco puro. Colonne in Supermatt Lux Grigio Ferro opaco. Base sospesa e cappa Supermatt Lux Carta Zucchero opaco. Blocco cottura in acciaio, top e schienale laminato Olmo Bianco. Elemento pensile a giorno Jolly Evo in laccato Piombo con interno Supermatt Lux Carta Zucchero opaco. Tavolo Jolly, sedie Noemi e sgabello Zedy.

Base units and wall units in Bianco Puro Supermatt. Lux Grigio Ferro Opaco Supermatt tall units. Lux Carta Zucchero Supermatt suspended base units and hood. Steel cooking unit. Olmo Bianco laminate top and back panel. Jolly Evo open wall unit, Piombo lacquered with Lux Carta Zucchero Opaco Supermatt interior. Jolly table, Noemi chairs and Zedy stool.





Il top della cucina, la base sospesa e l'elemento a giorno si estendono e proiettano la cucina verso il living.

The kitchen top, the suspended base unit and the open element reach out and connect the kitchen with the living area.



06 | **NATURAL** *style*
ESEMPI DI ABBINAMENTI / PAIRING EXAMPLES

IDEA *for*
DECOR

WALL PAPER
INSPIRATION

ROVERE SABBIA



SUPERMATT / IRON OPACO



LAMINATO / BIANCO PURO LUCIDO

MAYA COMPOSIZIONE 06. Il Rovere Sabbia è il punto di partenza per una cucina dall'aspetto naturale, ma molto contemporaneo. Insieme al bianco, nella sua versione lucida o materica, e al grigio opaco, le finiture effetto legno creano abbinamenti versatili che si adattano sia all'area kitchen, sia alla zona giorno.

MAYA COMPOSITION 06. Rovere Sabbia is the starting point for a kitchen that looks natural, but has a very modern feel. The glossy or textured white and the matt grey join with the wood-like finish to create versatile pairings that are suitable for both the kitchen and the day area.



Basi in Supermatt Iron con maniglia MVAB. Colonne in Rovere Sabbia. Pensili in laminato lucido Bianco Puro. Elementi Tetris in laccato Bianco opaco ed elementi Jolly Evo con inserti in laccato Bianco opaco, in Rovere Sabbia e in Supermatt Iron opaco.

Iron Supermatt base units with MVAB handles. Rovere Sabbia tall units. Bianco Puro glossy laminate wall units. Tetris Elements in lacquered Bianco Opaco and Jolly Evo elements with lacquered inserts in Bianco Opaco, in Rovere Sabbia and in Supermatt Iron Opaco.





La penisola e gli elementi a giorno aprono un dialogo tra cucina e living.
Uno stile coordinato per più ambienti.

*The peninsula and the open elements unite the kitchen and living areas.
A coordinated style for different living environments.*



06 | **NATURAL** style
SOLUZIONI LIVING / LIVING SOLUTIONS



*MAYA LIVING SOLUTION
COMPOSIZIONE 6.
Elementi differenti per matrice stilistica,
ma scelti ed abbinati con un preciso ordine
compositivo, evidente nella disposizione
simmetrica dei mobili e nell'equilibrato
giustapporsi di colori.*

*MAYA LIVING SOLUTION
COMPOSITION 6.
Elements with differing styles have been
deliberately selected and arranged with
precision, order is highlighted by the
symmetrical arrangement of the furniture
and the balanced juxtaposition of colours.*



*La zona living oggi è
sempre più multifunzione e
componibile, per non sprecare
spazio e ottenere il miglior
risultato estetico.*

*The living area features an
increasingly multipurpose
modular design, which helps
save space and increases the
aesthetic appeal.*

07 | **NATURAL** style
ESEMPI DI ABBINAMENTI / PAIRING EXAMPLES

IDEA for
DECOR

WALL PAPER
INSPIRATION

NOCE PLATIN



SUPERMATT / BIANCO PURO OPACO

MAYA COMPOSIZIONE 07. Il bianco abbinato alle venature del Noce Platin accoglie in cucina la leggerezza e l'essenzialità dello stile nordico. Anche con pochi ingredienti è possibile dare vita a una cucina di tendenza, perché il bicolore compone geometrie che valorizzano il design e scandiscono gli spazi. Minimal ma di grande effetto.

MAYA COMPOSITION 07. Pairing white with Noce Platin grains gives the kitchen the light, minimalist feel of the Nordic style. A few simple ingredients are enough to create a trendy kitchen; the two-tone geometric approach highlights design and marks out the different kitchen spaces. Minimal, but with a powerful effect.





COMPOSITION | 07 *Basi, pensili e colonne da 30 in Supermatt Bianco Puro opaco. Colonne, pensili e cassetti in Noce Platin.*

Bianco Puro Opaco Supermatt base units, wall units and tall units, size 30. Noce Platin tall units, wall units and drawers.

DESIGN *style*

kitchen solution

IDEA *for*
DECOR

WALL PAPER
INSPIRATION

SURPERMATT LUX / ROSSO MATTONE OPACO



NOCE DIAMOND

MAYA COMPOSIZIONE 08. La purezza del design si esprime attraverso un rosso intenso abbinato alla finitura chiara Noce Diamond e a rivestimenti materici scuri. Un tris d'effetto che traduce in colori e materiali un fascino hi-tech e un'estrema funzionalità. La cucina ideale per gusti forti e decisi.

MAYA COMPOSITION 08. Pure design is brought out by pairing an intense red with a light Noce Diamond finish and dark textured upholstery. The triad of colours and materials underscores a fascination with all that is functional and hi tech. A kitchen expressing bold tastes for a determined personality.





COMPOSITION | 08

Basi e pensili in Noce Diamond. Maniglia Diamond finitura Titanio. Colonne in Supermatt Lux Rosso mattone. Elementi a giorno Liberty in Supermatt Rosso Mattone opaco. Zoccolo e cappa IPE finitura Peltro. Top in marmo Petit Granit Fiammato patinato. Carrello Amico con ruote in finitura Peltro.

Noce Diamond base units and wall units. Diamond handle Titanio finish. Lux Rosso mattone Supermatt tall units. Rosso Mattone Opaco Supermatt Liberty open elements. Peltro finish plinth and IPE hood. Petit Granit Fiammato Opaco marble top. Kitchen Trolley wheels with Peltro finish.

09 | DESIGN *style*
ESEMPI DI ABBINAMENTI / PAIRING EXAMPLES

IDEA *for*
DECOR

WALL PAPER
INSPIRATION

SUPERMATT LUX / ROSSO MATTONE OPACO

SUPERMATT / BIANCO PURO OPACO

SUPERMATT / IRON OPACO

MAYA COMPOSIZIONE 09. Il bianco è l'ingrediente principale che sta bene con tutto, il grigio è il partner che lo accompagna e il colore rosso è il dettaglio che si fa notare: tre finiture per una cucina moderna nelle linee e nella composizione. Il design sceglie una formula sempre attuale e ultra young.

MAYA COMPOSITION 09. White is the key ingredient and matches anything, grey is the perfect partner, while the red highlights help it all stand out. Three finishes make for a kitchen that is modern both in shape and composition. An ultra young design formula to keep up with the times.





COMPOSITION | 09

*Basi in Supermatt Iron con maniglia Onda
finitura Peltro. Colonne in Supermatt Bianco
Puro. Pensili in Supermatt Bianco Puro e Iron.
Elementi a giorno colore Rosso Mattone opaco. Top
e alzatina in Fenix Grigio Bromo. Sgabelli Light.*

*Iron Supermatt base units and Onda handle with
Peltro finish. Bianco Puro Supermatt tall units.
Bianco Puro and Iron Supermatt wall units.
Rosso Mattone Opaco open elements. Fenix Grigio
Bromo top and upstand. Light stools.*

10 | DESIGN *style*
ESEMPI DI ABBINAMENTI / PAIRING EXAMPLES

IDEA *for*
DECOR

DESIGN
INSPIRATION

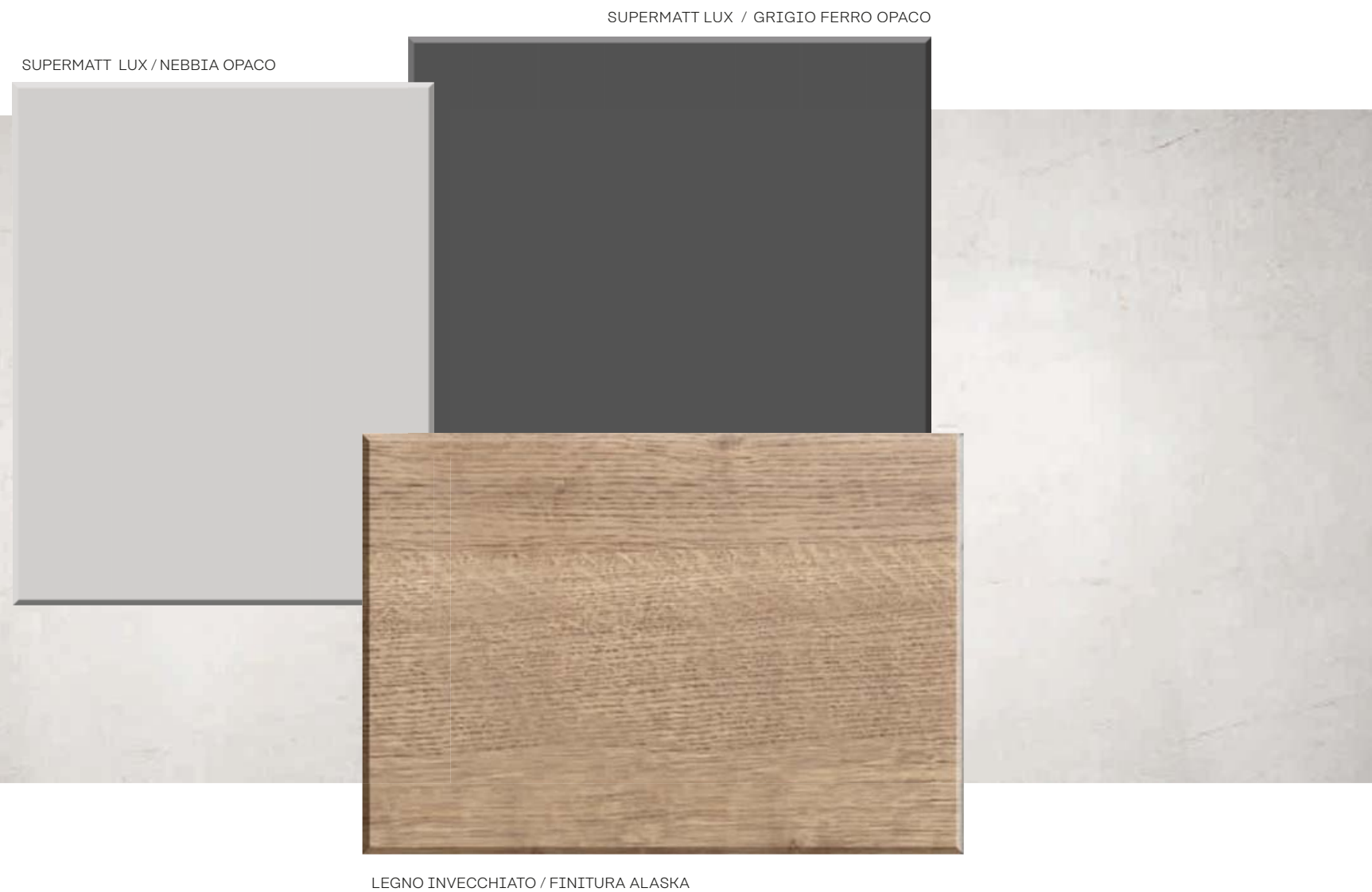

SUPERMATT LUX / GRIGIO FERRO OPACO

SUPERMATT LUX / NEBBIA OPACO

LEGNO INVECCHIATO / FINITURA ALASKA

MAYA COMPOSIZIONE 10. Superfici lisce in tonalità di grigio dai toni chiari e caldi al deciso Grigio Ferro per una cucina dallo stile sobrio e rigoroso. Legno naturale e bagliori di acciaio stemperano i toni e danno luminosità alla cucina. La combinazione giusta per chi vuole valorizzare il design attraverso i contrasti.

MAYA COMPOSIZIONE 10. Smooth surfaces with grey tones varying from the light and welcoming to a bold Grigio Ferro for a kitchen with a sober rigorous style. Natural wood and steel accents provide variety and brighten up the kitchen. The perfect combination for those who wish to highlight design through contrast.





COMPOSITION | 10 *Isola centrale con basi in Supermatt Lux Grigio Ferro opaco. Colonne in Supermatt Lux Nebbia opaco. Elementi a giorno in legno invecchiato finitura Rovere Alaska. Piano tavolo Snack in finitura Rovere Alaska con gamba in vetro. Sgabelli Light.*

Central island with Lux Grigio Ferro Opaco Supermatt base units. Lux Nebbia Opaco tall units. Open elements in aged wood Rovere Alaska finish. Snack table top with Rovere Alaska finish and glass leg. Light stools.



In versione naturale, il legno caratterizza il bancone e torna sugli elementi a giorno di isola e colonne.

The natural wood look of the counter connects it to the open elements of the island and tall units.





Vetro per dare leggerezza al top dal forte spessore o cavalletto per un tavolo casual che può diventare scrivania.

Glass to give the significantly thick top a lighter feel, or a stand for a casual table that can also serve as a desk.



URBAN *style*

kitchen solution

IDEA *for*
DECOR

WALL PAPER
INSPIRATION

LACCATO OPACO / BLU TURCHESE



ROVERE JEANS

MAYA COMPOSIZIONE 11. Una finitura effetto legno e un laccato opaco chiaro interpretano lo stile urban con semplicità. L'aggiunta di una carta da parati "ethnic style" nelle stesse tonalità sottolinea il look metropolitano. In cucina si crea una relazione armonica tra materiali, design e decorazione.

MAYA COMPOSITION 11. The wood effect of the finish and the light matt lacquer offer a simple urban style. Adding ethnic-themed wallpaper with the same tones highlights the metropolitan look. Materials, design and decoration find harmony in the kitchen.





COMPOSITION | 11

Basi, colonne e colonne midi in Rovere Jeans. Cassetto da 120 in laccato Blu Turchese opaco. Pensili in Rovere Jeans e laccato Blu Turchese opaco. Elementi Jolly Evo con inserti in finitura Rovere Jeans.

Rovere Jeans base units, tall units and midi tall units. Blu Turchese Opaco lacquered drawer, size 120. Rovere Jeans wall units with Blu Turchese Opaco lacquer. Jolly Evo elements with Rovere Jeans finish for the inserts.



In cucina lo spazio è fondamentale.
Se inoltre è illuminato, diventa ancora
più accessibile e funzionale.

When it comes to the kitchen, space is key. While good lighting makes everything more practical and accessible.



Questa composizione ottimizza l'open space grazie ad una cucina con una forte aspettativa nei confronti di volumi salvaspazio. Linee forti e decise, percorrono le composizioni che utilizzano la presa maniglia. Un elemento decorativo e funzionale che punta all'essenzialità.

This composition optimises the open space thanks to a kitchen that contributes greatly to space-saving areas. Bold lines run across the composition; the handle grips serve as both a functional and decorative element, focusing on the essential.



12 | **URBAN** *style*
ESEMPI DI ABBINAMENTI / PAIRING EXAMPLES

IDEA *for*
DECOR

WALL PAPER
INSPIRATION

NOCE DIAMOND

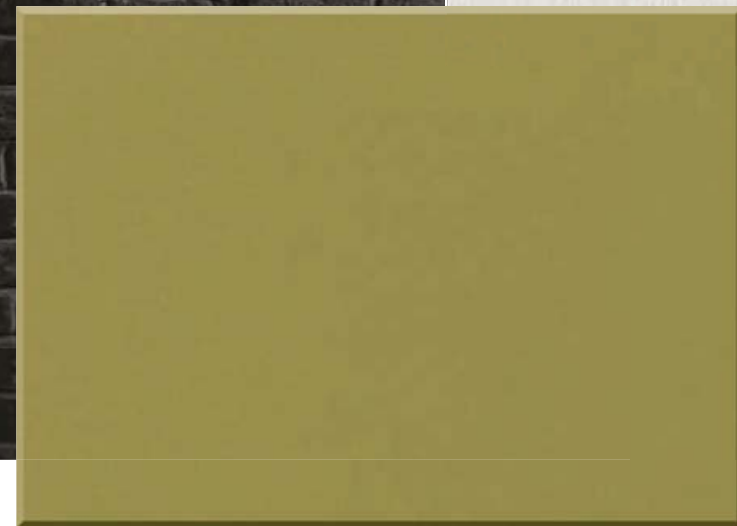

ELEMENTI A GIORNO / VERDE OLIVA OPACO

MAYA COMPOSIZIONE 12. Un ingrediente speciale nella composizione in Noce Diamond: il Verde Oliva, a piccole dosi, è perfetto per dare quel sapore in più alla cucina. I mattoni sono un elemento irrinunciabile per un ambiente in pieno stile urban e se scelti in una tonalità dark fanno risaltare al massimo le finiture chiare.

MAYA COMPOSITION 12. A special ingredient for the Noce Diamond composition: small doses of Verde Oliva, give the kitchen just a tad more flavour. Bricks are a must for a full-blown urban style and choosing darker shades brings out the light finishes.



*Basi, pensili e colonne in Noce Diamond.
Elementi a giorno colore Verde Oliva opaco.
Elementi Jolly Evo con inserti in finitura
Noce Diamond. Sedie Noemi.*

*Noce Diamond base units, wall units and
tall units. Verde Oliva Opaco for the open
elements. Jolly Evo elements with a Noce
Diamond finish for the inserts. Noemi chairs.*



13 | **URBAN** *style*
ESEMPI DI ABBINAMENTI / PAIRING EXAMPLES

IDEA *for*
DECOR

DESIGN
INSPIRATION

BIANCO PURO

SUPERMATT LUX / GRIGIO FERRO OPACO

LACCATO OPACO / ORANGE

SUPERMATT LUX / CARTA DA ZUCCHERO OPACO

MAYA COMPOSIZIONE 13. Come base Grigio Ferro e in aggiunta un po' di azzurro carta da zucchero, e un tocco di intramontabile bianco puro. La texture grafica della carta da parati fa da sfondo a tutti gli elementi e li amalgama. La ricetta è pronta per dare forma a una cucina dal mood urbano e dalla personalità contemporanea.

MAYA COMPOSITION 13 Grigio Ferro provides a base colour with a hint of baby blue, and, of course, a touch of bianco puro. The graphic texture of the wallpaper serves as a common background uniting all the elements. The perfect recipe for a kitchen with an urban mood and a modern personality.





COMPOSITION | 13

Basi in Supermatt Lux Grigio Ferro opaco. Colonna frigo in Supermatt Bianco Puro, colonna da 45 in Supermatt Lux Carta Zucchero opaco e colonna midi in Supermatt Lux Grigio Ferro opaco. Pensili in Supermatt Bianco Puro opaco. Elementi Jolly Evo con inserti in laccato Orange opaco.

Lux Grigio Ferro Opaco Supermatt base units. Bianco Puro Supermatt fridge tall unit, Lux Carta Zucchero Opaco Supermatt tall unit, size 45 and Lux Grigio Ferro Opaco Supermatt midi tall unit. Bianco Puro Opaco Supermatt wall units. Jolly Evo elements with Orange Opaco lacquered inserts.

ROUND *style*

kitchen solution

IDEA *for*
DECOR

DESIGN
INSPIRATION

SUPERMATT / IRON OPACO



SUPERMATT / DESERT OPACO

MAYA COMPOSIZIONE 14. Due tonalità neutre, una chiara e delicata, l'altra più scura e decisa dettano lo stile di un ambiente in equilibrio tra calore e modernità. L'elegante contrasto mette in risalto i volumi arrotondati degli elementi e ne accentua il dinamismo. La cucina ha un aspetto femminile molto chic.

MAYA COMPOSIZIONE 14. Two neutral tones, one light and delicate, the other darker and bolder set the style for an environment that blends warmth and modernity. The elegant contrast highlights the rounded shapes of the elements for a more dynamic feel. A kitchen with a feminine appeal, very chic.





15 | **ROUND** *style*
ESEMPI DI ABBINAMENTI / PAIRING EXAMPLES

IDEA *for*
DECOR

DESIGN
INSPIRATION

LAMINATO / CREMA IRIDESCENTE



NOCE PLATIN

MAYA COMPOSIZIONE 15. A dettare lo stile della cucina sono le tonalità tenui del Crema e la raffinata texture del Noce Platin. C'è una vena romantica in questi ricercati abbinamenti che reinterpreta il gusto della tradizione in chiave contemporanea. Un ambiente progettato per l'ospitalità e il piacere di stare insieme.

MAYA COMPOSITION 15. In the kitchen, the style is set by the soft Cream-coloured tones and the refined Noce Platin texture. A romantic vein runs through these sought out pairings, putting a modern spin on a traditional taste. It's an environment designed for hospitality and pleasant socialising.



Basi, colonne e pensili in finitura Crema Iridescente con maniglia MVAC. Pensile cappa ed elementi a giorno per pensili e colonne in finitura Noce Platin.

Bases, tall units and wall units in Crema Iridescente finish with MVAC handles. Hood units and open elements of the tall units and wall units feature a Noce Platin finish.



GOLE | GROVEE



GOLA PIATTA
CON TASCA
DISPONIBILE
IN 5 COLORI:
TITANIO, BRILL,
BIANCO
PIOMBO E PELTRO

*Flat groove with pocket
Available in 5 colors: Titanium,
brill, white, lead and pewter.*

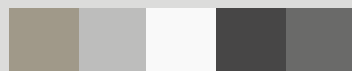

GOLA SCAVATA
DISPONIBILE IN 10
COLORI: TITANIO,
BRILL, BIANCO
PIOMBO, CORDA,
ROSSO, GIALLO,
ARANCIONE, OLIVA
E ACQUAMARINA.

*Hollow groove available in 10
colors: Titanium, brill, white, lead,
cord, red, yellow, orange,
olive and aquamarine.*



MANIGLIE | HANDLES



MVAC
*Nichel Opaco Satinato
Nickel Satin Matt*

MVAB
*Bronzo Titanio
Bronze Titanium*



ONDA COD. M2 C
*Maniglia finitura brill
Brill finish handle
Non disponibile per ante curve
Not available on curved elements*



NAKED_MTA
Peltro



DIAMOND

FINITURE & COLORI | FINISHINS AND COLORS

TERMO STRUTTURATO
Thermo - Structured



NOCE DIAMOND



NOCE PLATIN



ROVERE JEANS

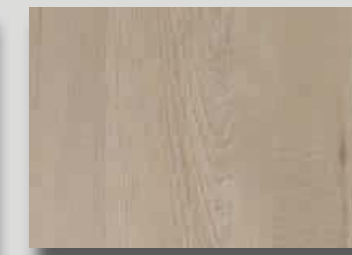

ROVERE SABBIA

LAMINATO
LUCIDO -
IRIDISCENTE
*Glossy Laminate
Iridescent*

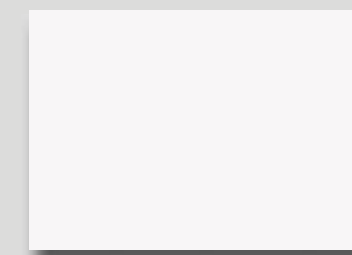

BIANCO PURO

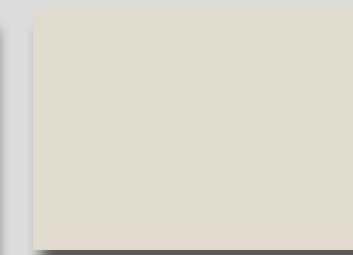

DESERT



IRON

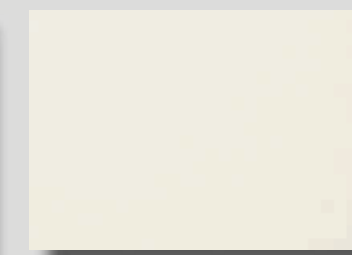

LAMINATO CREMA
IRIDISCENTE

SUPERMATT

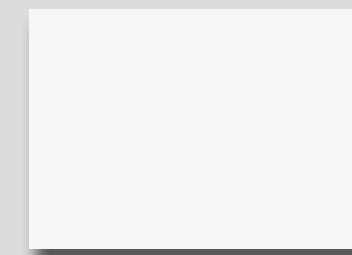

BIANCO PURO

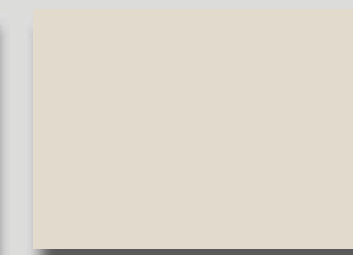

DESERT



IRON

SUPERMATT LUX
new colors

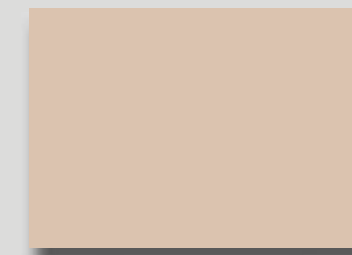

CIPRIA OPACO

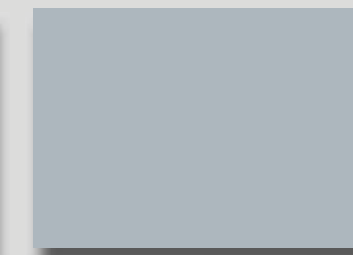

CARTA ZUCCHERO OPACO

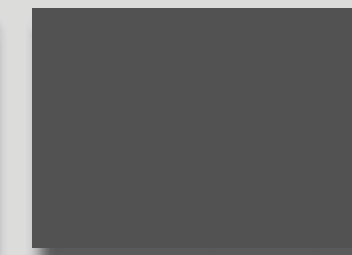

GRIGIO FERRO OPACO

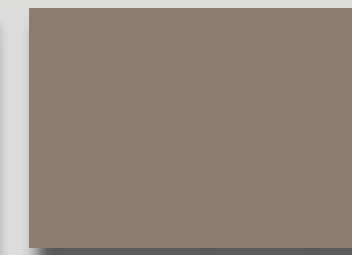

NOCCIOLA OPACO

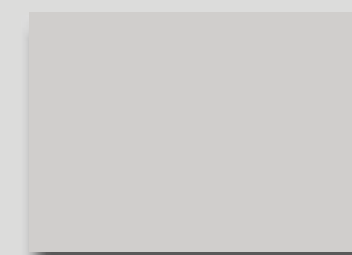

NEBBIA OPACO

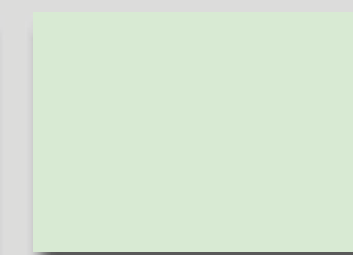

VERDE ACQUA OPACO

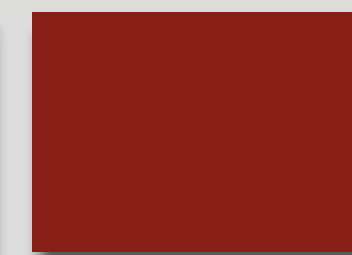

ROSSO MATTONE OPACO

ABACO DELLE COMPOSIZIONI

Maya
restyle

MAYA LA CUCINA CHE TI OFFRE MOLTISSIME POSSIBILITÀ DI SCELTA. ANTA CON O SENZA MANIGLIA, SORPRENDENTI FINITURE DA ABBINARE PER OTTENERE LA MASSIMA PERSONALIZZAZIONE.

MAYA: A KITCHEN THAT OFFERS A WIDE VARIETY OF CHOICES. DOORS WITH OR WITHOUT HANDLES AND SURPRISING FINISHES THAT CAN BE COMBINED FOR MAXIMUM CUSTOMISATION.



COMP. 01 | WOOD style page 4

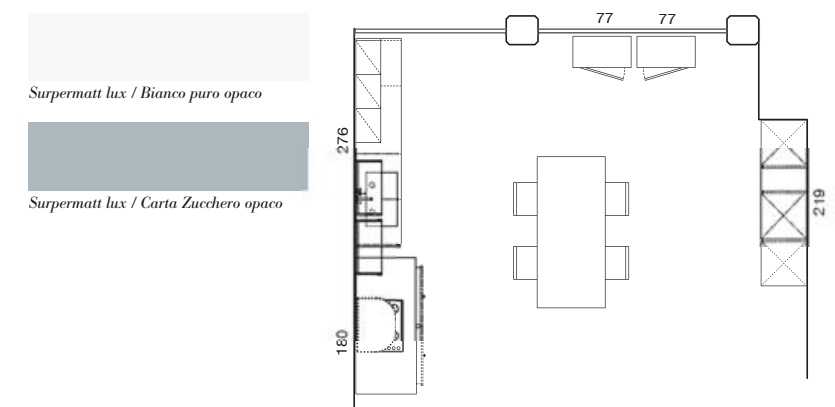

COMPOSITION SCHEDULES



COMP. 04 | URBAN style page 26

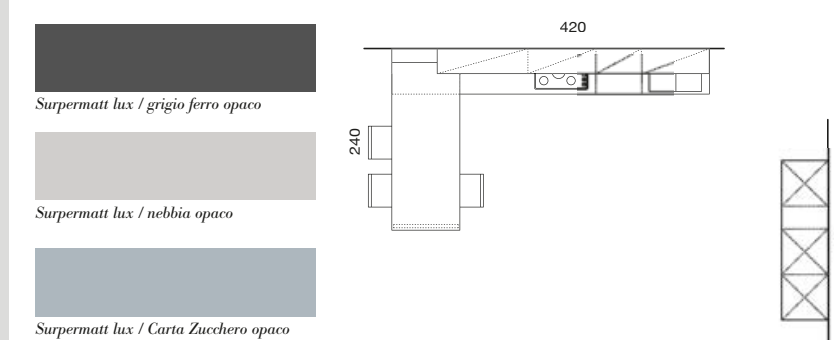

COMP. 05 | NATURAL style page 32

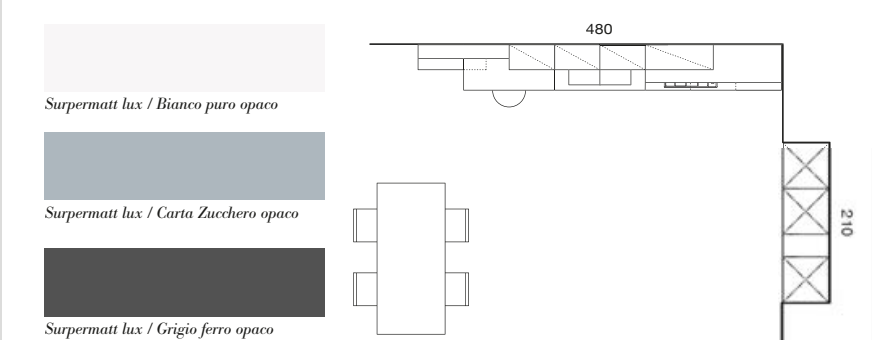

COMP. 02 | URBAN style page 14

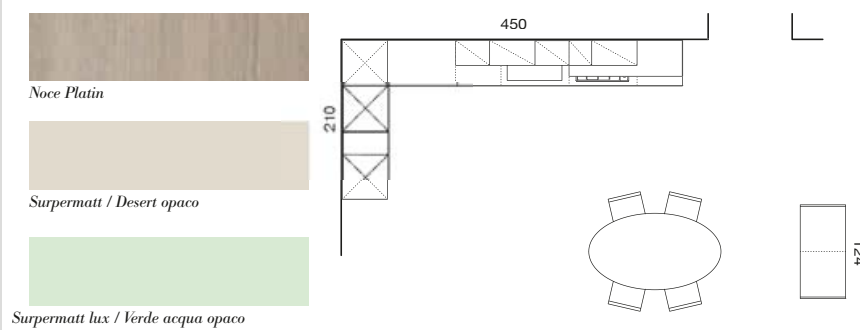

COMP. 03 | URBAN style page 20

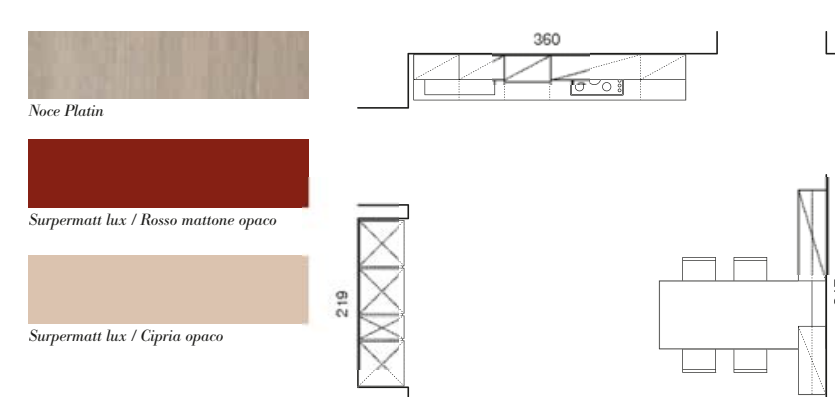

COMP. 06 | NATURAL style page 38

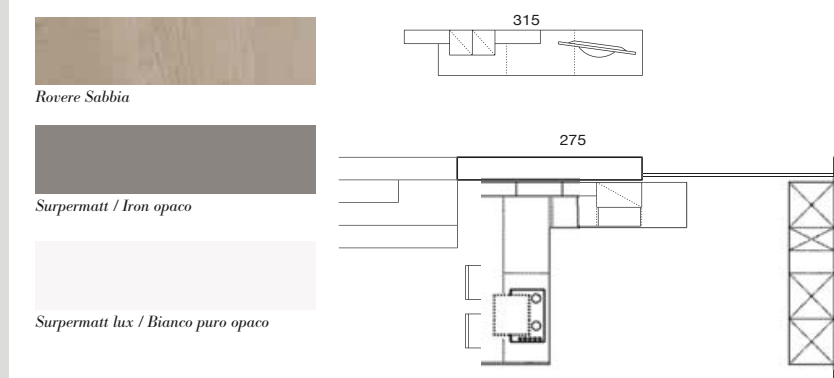

COMP. 07 | NATURAL style page 46

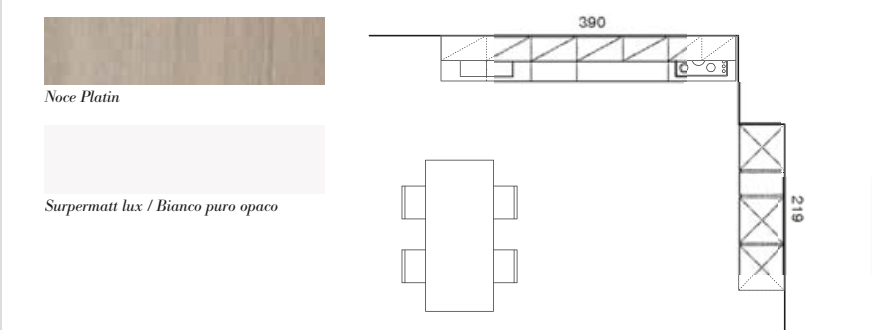

ABACO DELLE COMPOSIZIONI



COMP. 08 | DESIGN style page 50

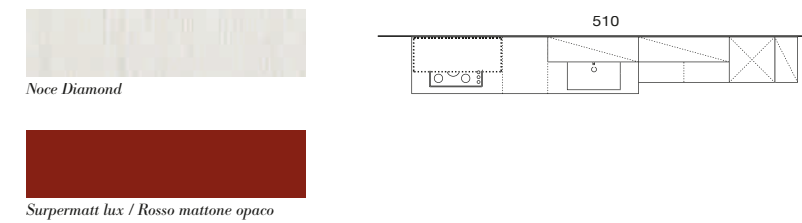

COMP. 09 | DESIGN style page 54

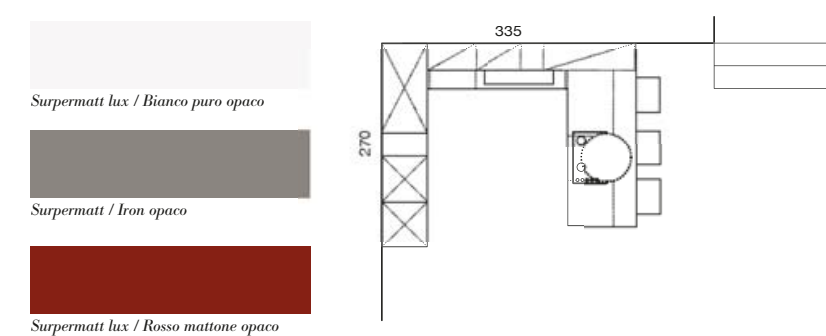

COMP. 12 | DESIGN style page 74

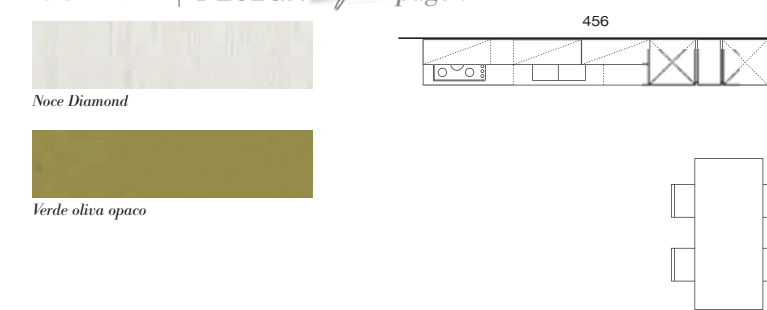

COMP. 13 | DESIGN style page 78

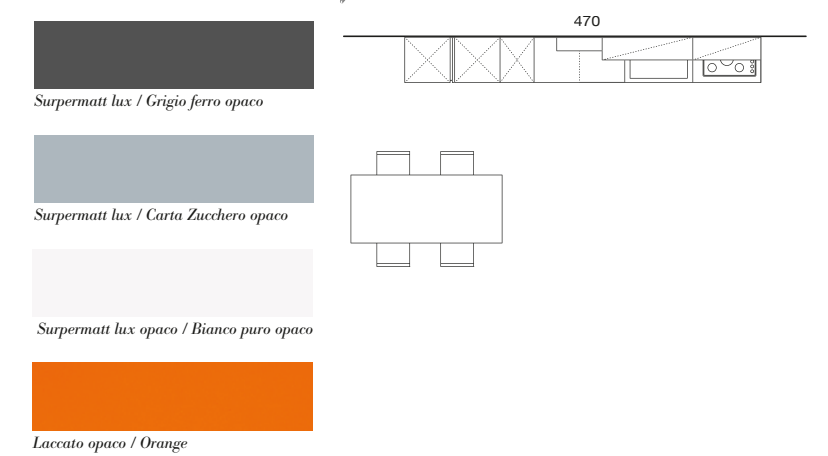

COMP. 10 | DESIGN style page 58

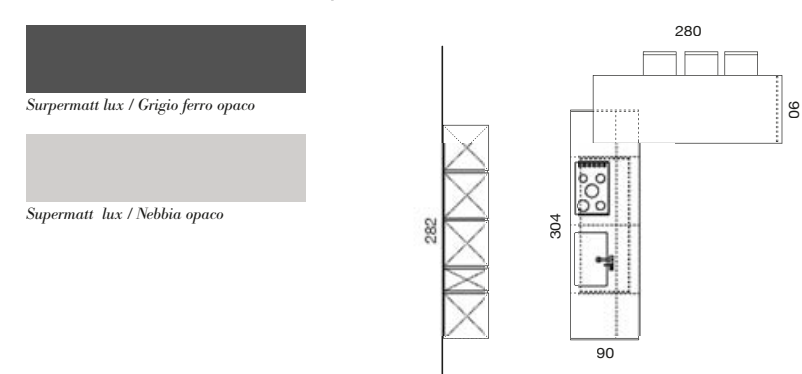

COMP. 11 | DESIGN style page 66

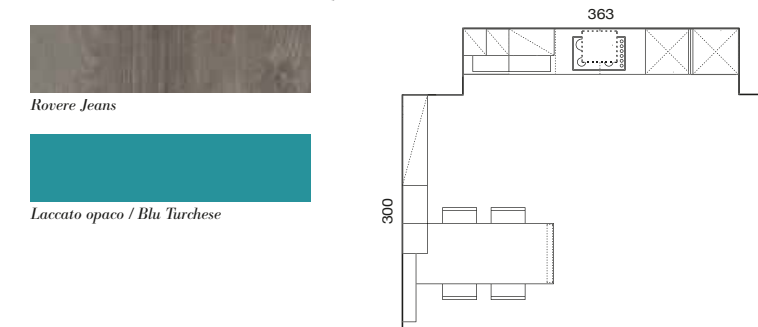

COMP. 14 | ROUND style page 82

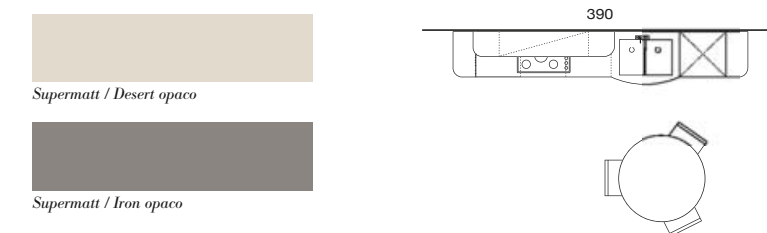

COMP. 15 | ROUND style page 86

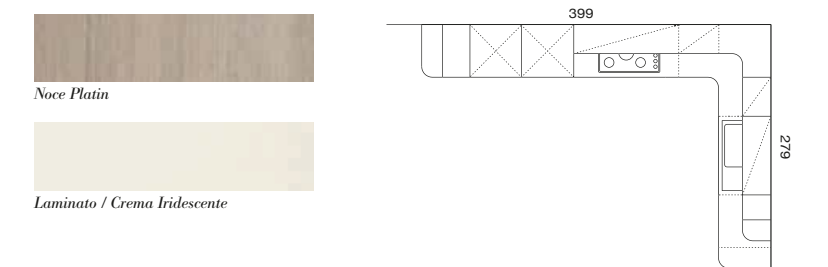

Maya
restyle

Design: Rossi & Co. Network Design
A. D. e Grafica: Rossi & Co. Network Design
Foto: Studio Indoor (Oderzo - TV)
Render: Studio Indoor (Oderzo - TV)
Fotolito: Z13
Stampa: Pazzini Stampatore Editore
Stampato in Italia





Stosa S.p.A.

STAB., SEDE AMM.VA E RECAPITO POSTALE:
S.S. Cassia, Km. 149,5
53040 Radicofani (SI) Italy

GPS:
N 42° 53' 50,6"
E 11° 45' 53,5"

INFO:
tel. +39 0578 5711 r.a.
fax +39 0578 50088

INFO LINE:
840 000 691

www.stosa.it stosa@stosa.it

